

LK 192 S120,140,160,180,200 D200

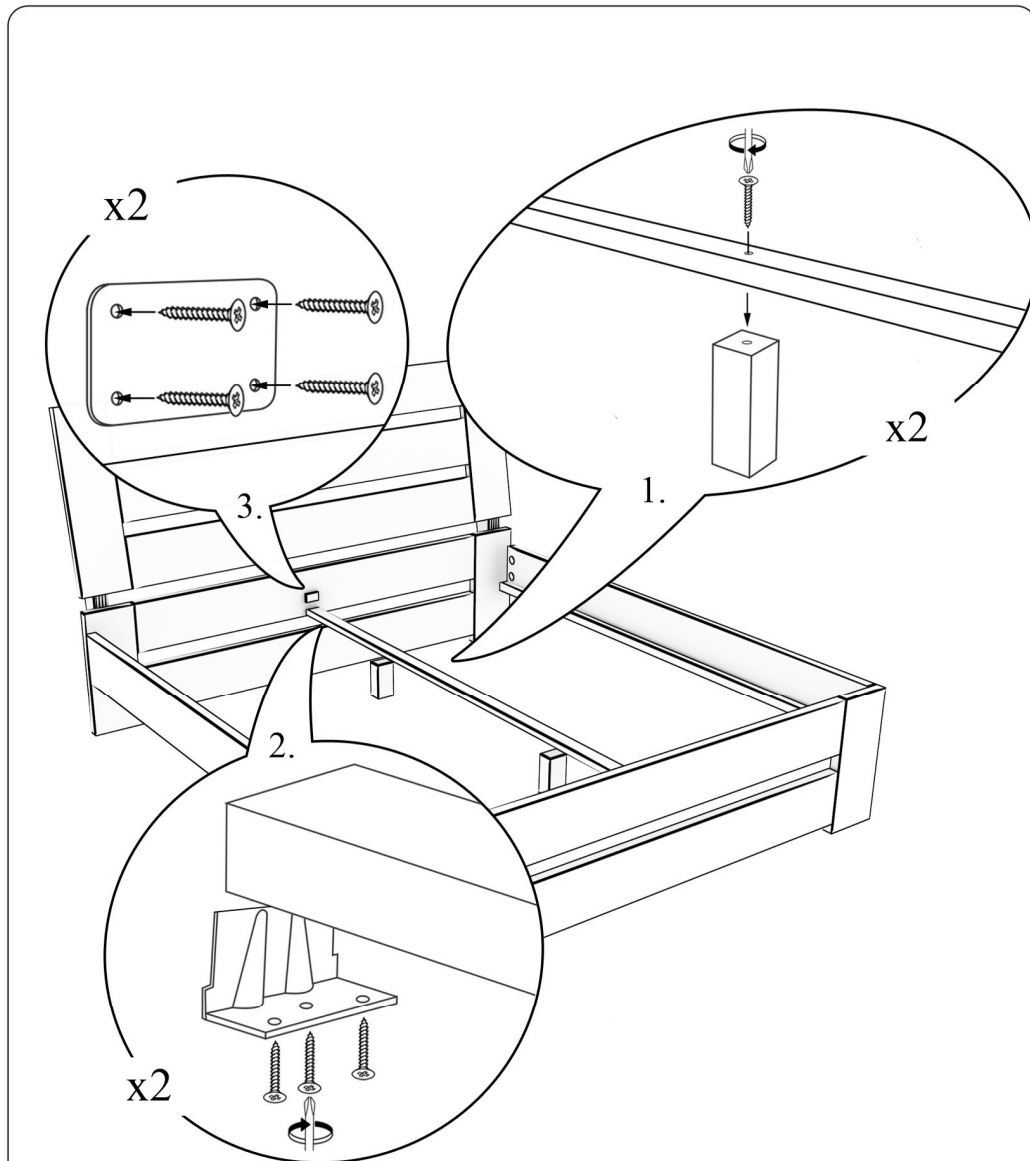

3.
 PL : Dla wzmocnienia konstrukcji zaleca się przykręcenie stelaża do ramy łóżka
 SK : Pre posilnenie konstrukcie, odporúčame rám roštu priskrutkovať na rám posteľe
 EN : To strengthen the bed construction it is recommended to screw
 the slat under the mattress to frame of the bed
 CS : Prt posilnenie strukturu, doporučuje se šroub rámeček na rám posteľe

