

Potrzebne dodatkowo
przy montażu

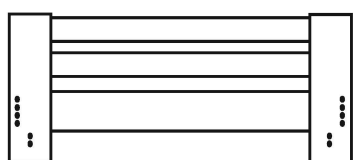

Elementy łóżka



zagłowie 1x

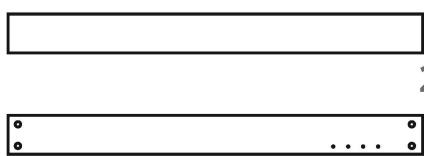

boki 2x



zanózek 1x

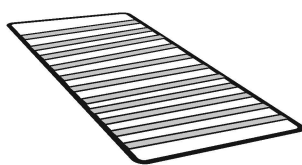

stelaż 1x przy łóżkach 90/100
2x przy łóżkach 120/140/160/180/200

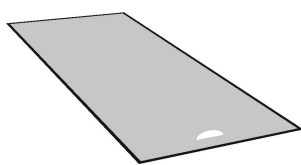

podłoga 1x przy łóżkach 90/100
2x przy łóżkach 120/140/160/180/200



sznurek 1x

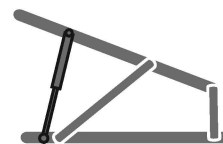

trójkąt z siłownikiem
do mocowania stelaża 2x

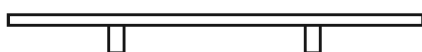

listwa z dodatkowymi nogami 1x przy łóżkach 120/140/160/180/200

Elementy łączące

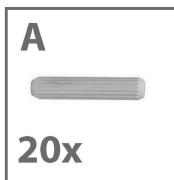

kołek drewniany

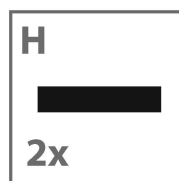
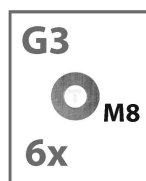
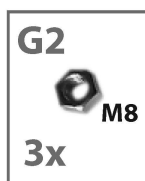
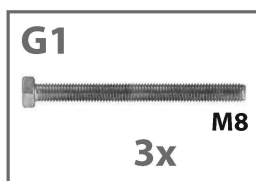
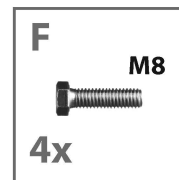
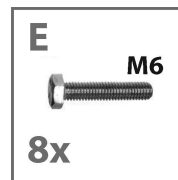
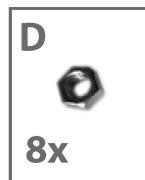
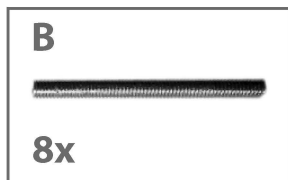

wzmocnienie
stalowe

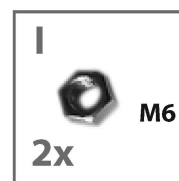

Podczas skręcania łóżka zachowujemy najwyższą staranność, a wszystkie śruby dokręcamy z wycuciem do momentu kiedy zaczynają stwarzać wyczuwalny opór.

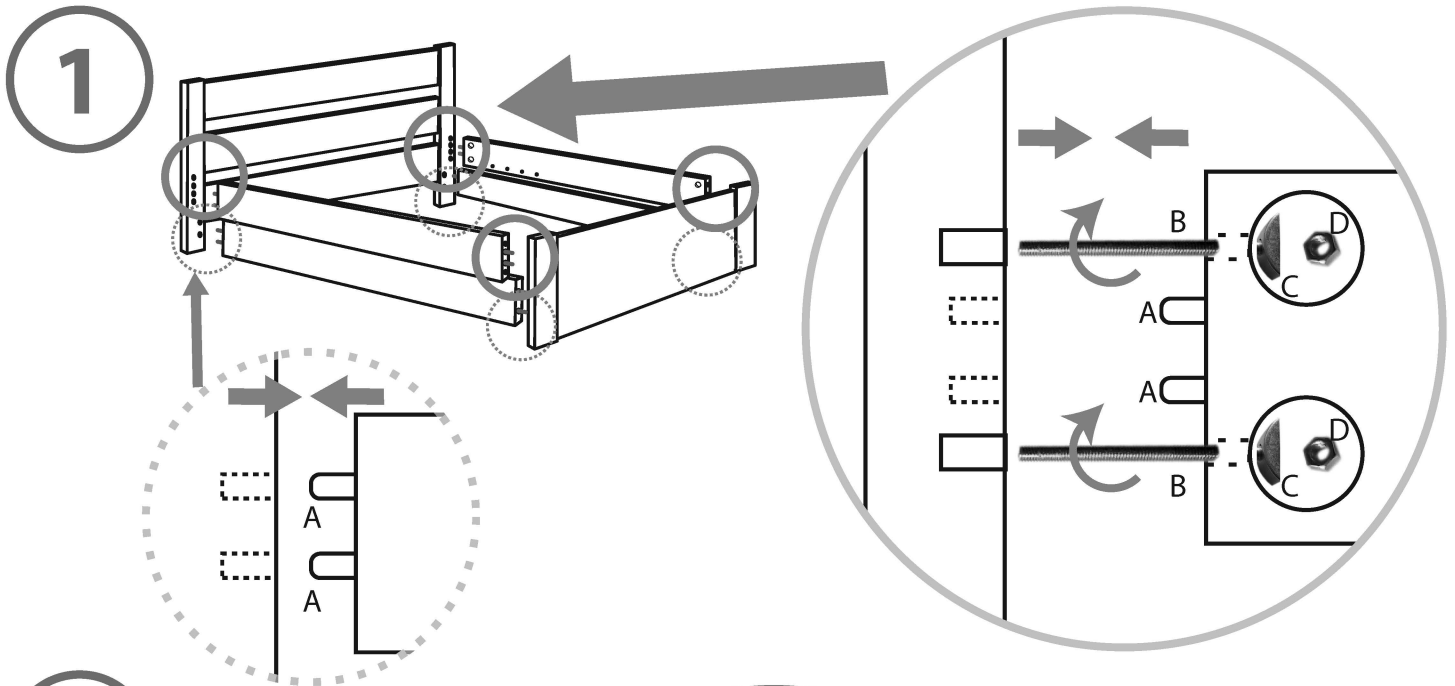

2

! W łóżkach z otwieraniem bocznym otwory do mocowania trójkąta z siłownikiem znajdują się w zagłówku i zanóżku

! W łóżkach z otwieraniem bocznym burtę z zamontowaną listwą do podtrzymywania stelaża należy zamontować po przeciwległej stronie niż siłowniki: tzn. po stronie gdzie chcemy otwierać stelaż

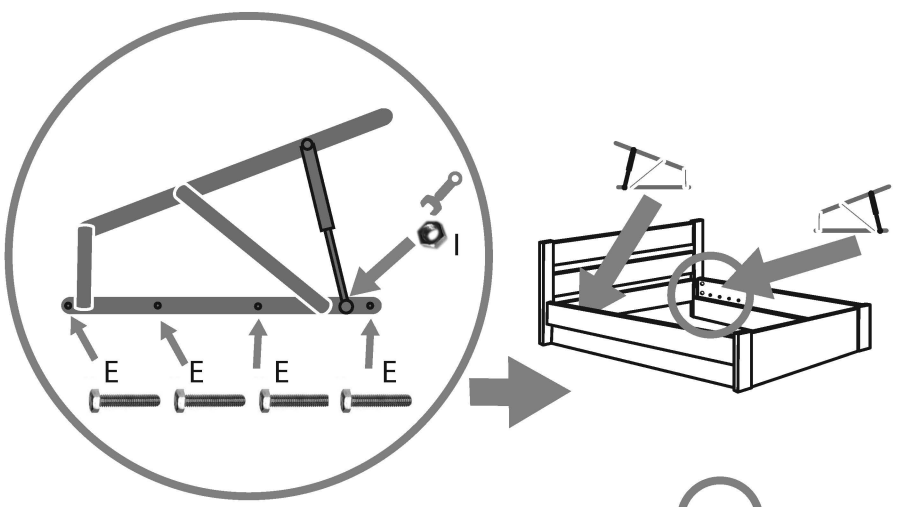

3a

dotyczy łóżek 120/140/160/180/200

WAŻNE !!!

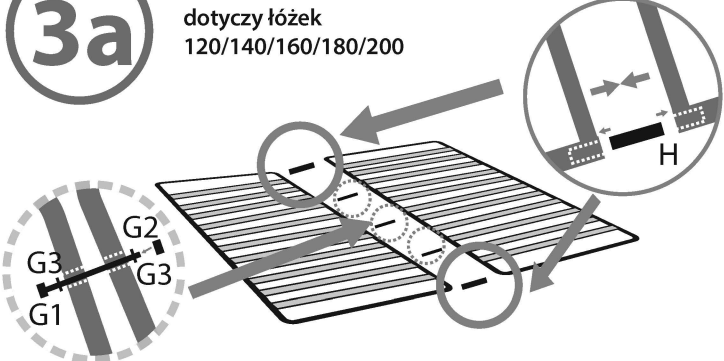

3b

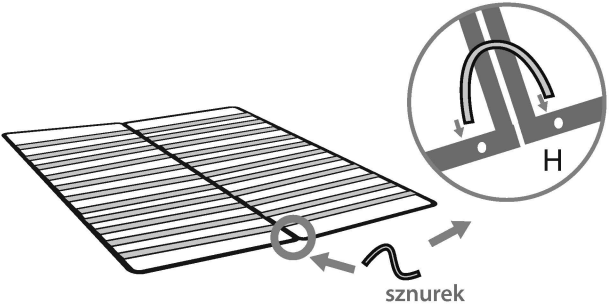

4

