

Potrzebne dodatkowo
przy montażu

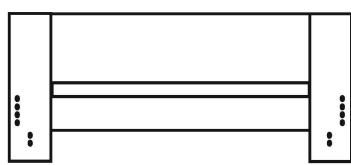

Elementy łóżka



zagłowie 1x

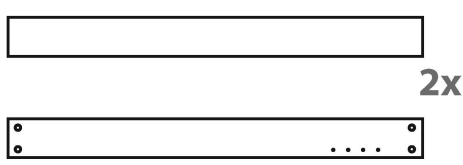

boki 2x



zanózek 1x

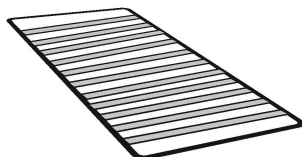

stelaż

1x
przy łóżkach
90/100

2x
przy łóżkach
120/140/160/180/200

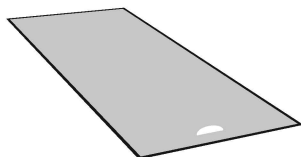

podłoga

1x
przy łóżkach
90/100

2x
przy łóżkach
120/140/160/180/200



sznurek 1x

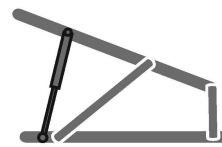

2x

trójkąt z siłownikiem
do mocowania stelaża



listwa z dodatkowymi nogami

1x
przy łóżkach
120/140/160/180/200

Elementy łączące

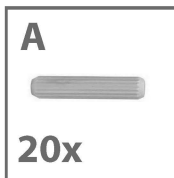

20x

kołek drewniany



8x



8x

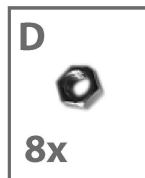

8x

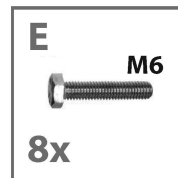

8x

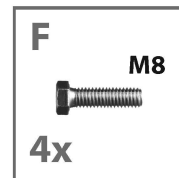

4x

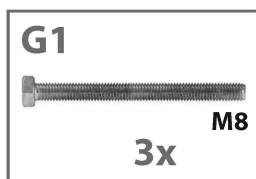

G1

3x

M8

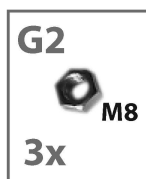

G2

3x

M8

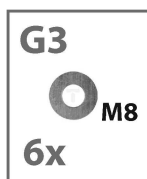

G3

6x

M8

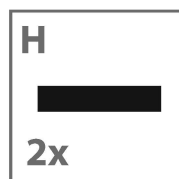

H

2x

wzmocnienie
stalowe

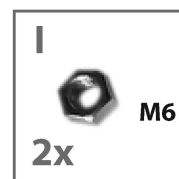

I

2x

M6



Podczas skręcania łóżka zachowujemy najwyższą staranność, a wszystkie śruby dokręcamy z wycuciem do momentu kiedy zaczynają stwarzać wyczuwalny opór.

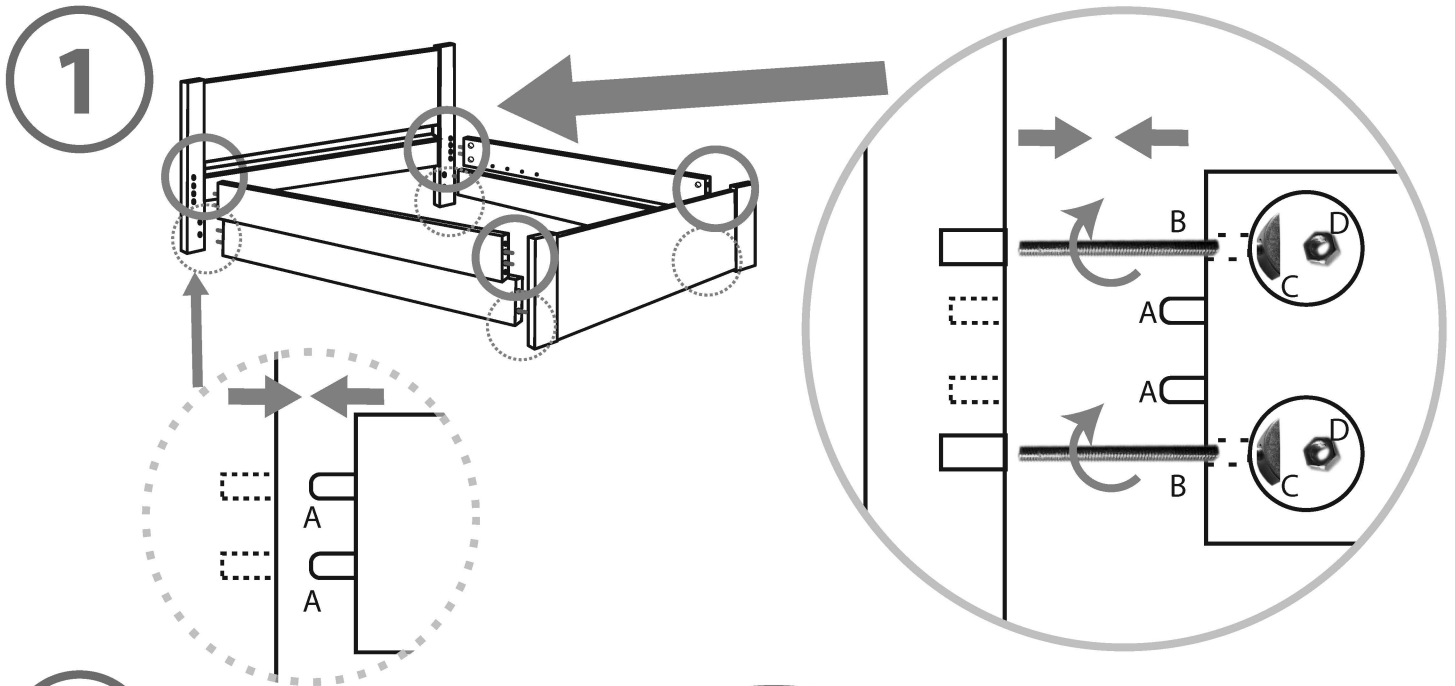

2

! W łóżkach z otwieraniem bocznym otwory do mocowania trójkąta z siłownikiem znajdują się w zagłówniu i zanózku

! W łóżkach z otwieraniem bocznym burtę z zamontowaną listwą do podtrzymywania stelaża należy zamontować po przeciwległej stronie niż siłowniki: tzn. po stronie gdzie chcemy otwierać stelaż

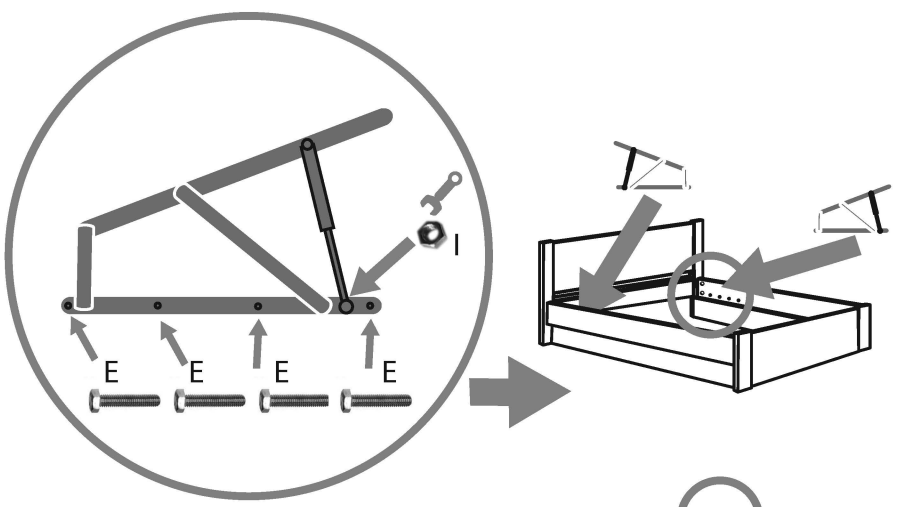

3a

dotyczy łóżek 120/140/160/180/200

WAŻNE !!!

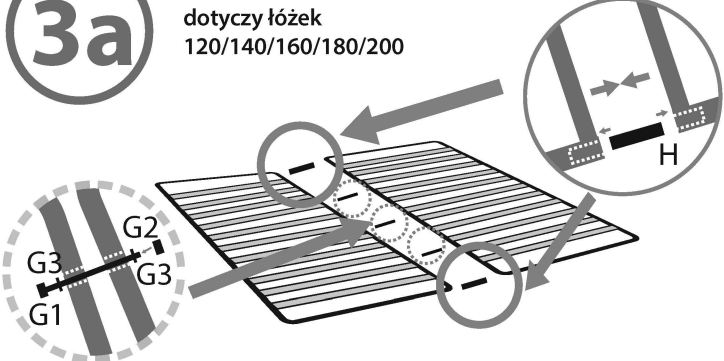

3b

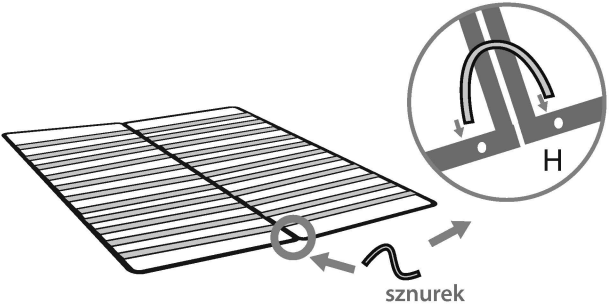

4

